

Technical Information

Reference Purpose Only.

Model

NDG7575

Features

- **Optical Output Power : 1000mW**
- **Multi Transverse Mode**
- **Can Type : ϕ 9.0mm Floating Mounted with Zenger Diode**

Specifications

Reference Purpose Only.

Absolute Maximum Ratings

Item	Symbol	Absolute Maximum Ratings	Unit
Forward Current (Tc=25°C)	If	2.0	A
Allowable Reverse Current (Tc=25°C)	Ir(LD)	85	mA
Storage Temperature	Tstg	-40 ~ 85	°C
Operating Case Temperature	Tc	0 ~ 60	°C

Initial Electrical/Optical Characteristics

(Tc=25°C)

Item	Condition	Symbol	Min.	Typ.	Max.	Unit	
Optical Output Power	If=1.6A	Po	0.7	(1.0)	-	W	
Dominant Wavelength	If=1.6A	λ_p	515	(520)	525	nm	
Threshold Current	CW	Ith	150	(230)	350	mA	
Slope Efficiency	CW	η	0.5	(0.7)	1.2	W/A	
Operating Voltage	If=1.6A	Vop	4.0	(4.6)	5.3	V	
Beam Divergence *	Parallel	If=1.6A	$\theta_{//}$	5.0	(11.0)	25.0	deg.
	Perpendicular		θ_{\perp}	35.0	(46.0)	55.0	deg.
Beam Pointing Accuracy	Perpendicular	If=1.6A	$\Delta\theta_{\perp}$	-5.0	-	5.0	deg.

() are reference figures.

* Full angle at $1/e^2$ from peak intensity.

All figures in this specification are measured by Nichia's method and may contain measurement deviations.

Outline

Reference Purpose Only.

Dimension

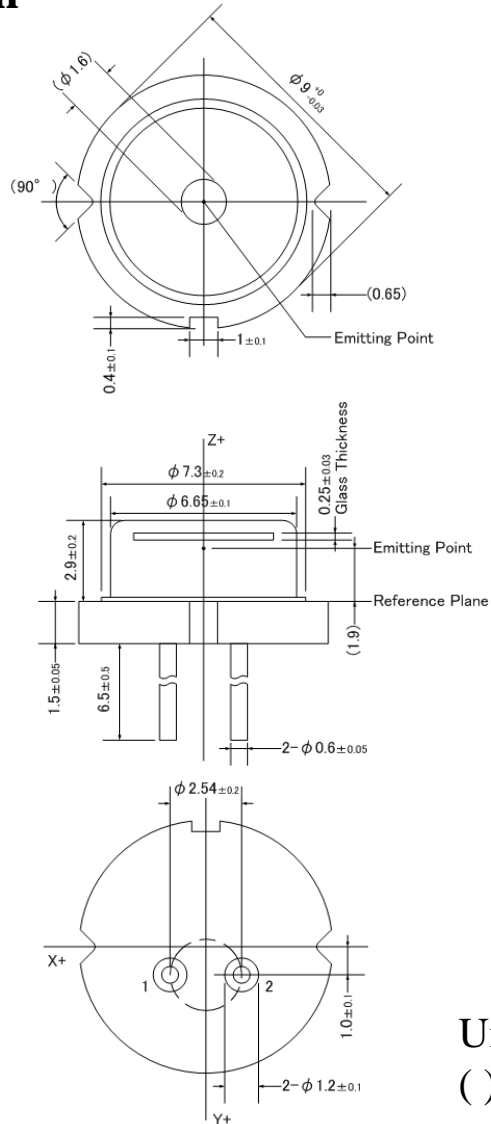

Unit (mm)
() are reference figures

Pin Connection

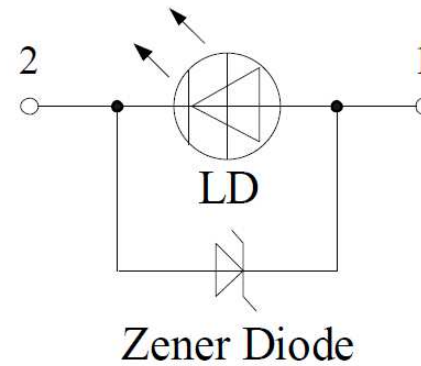

1. LD Anode
2. LD Cathode

This model has no Photo Diode.
This model has a Zenger Diode built in as a protection circuit against static electricity.

Typical Optical / Electrical Characteristics

Reference Purpose Only.

Condition : CW

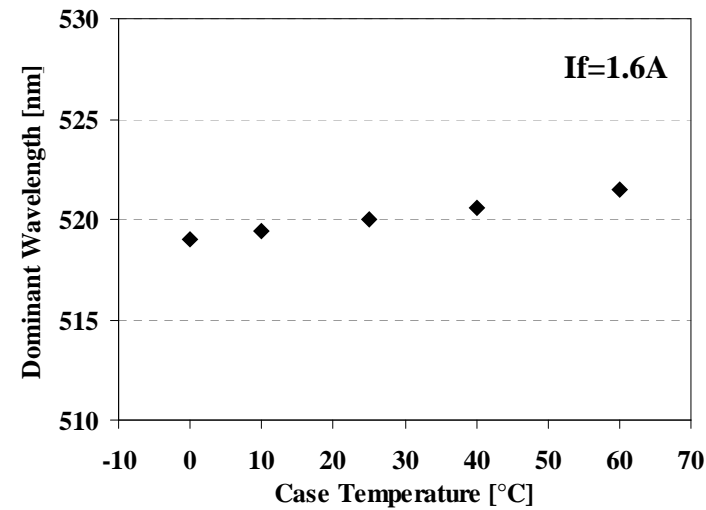
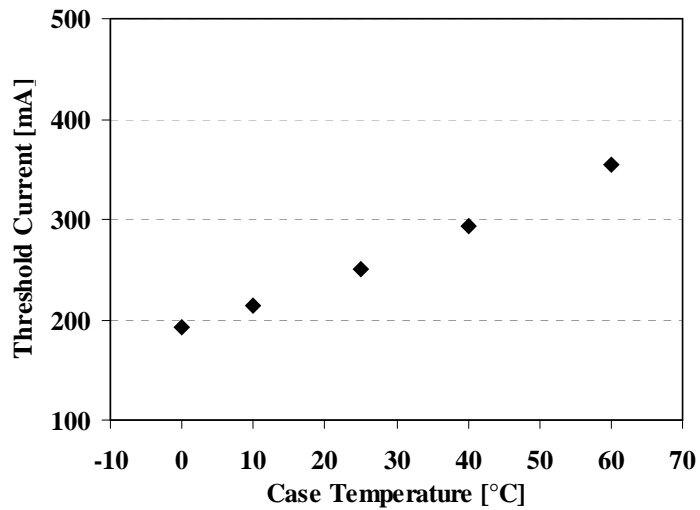
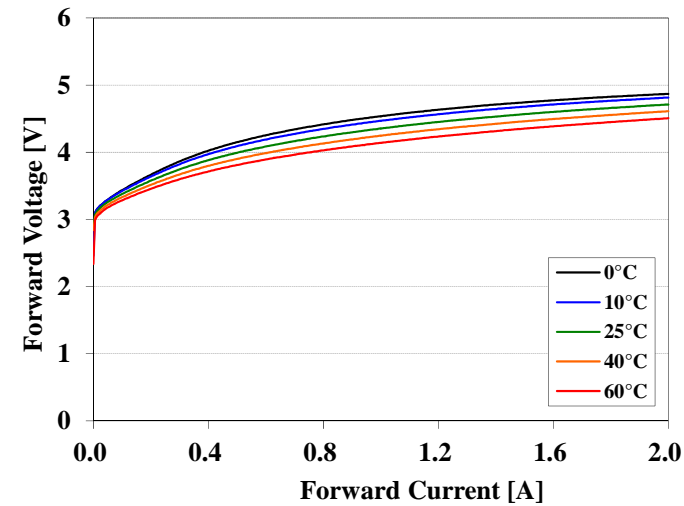
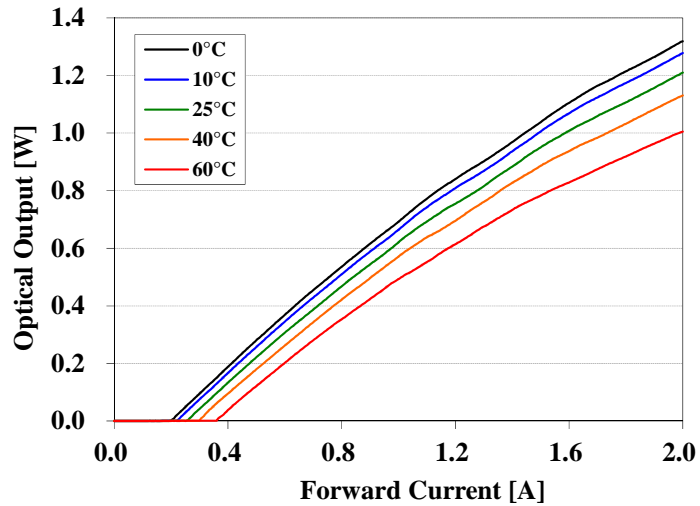

Spectrum1 (Forward Current Dependence)

Reference Purpose Only.

Condition : Case Temperature = 25°C
Forward Current = 0.8, 1.2, 1.6 A, CW
N = 10

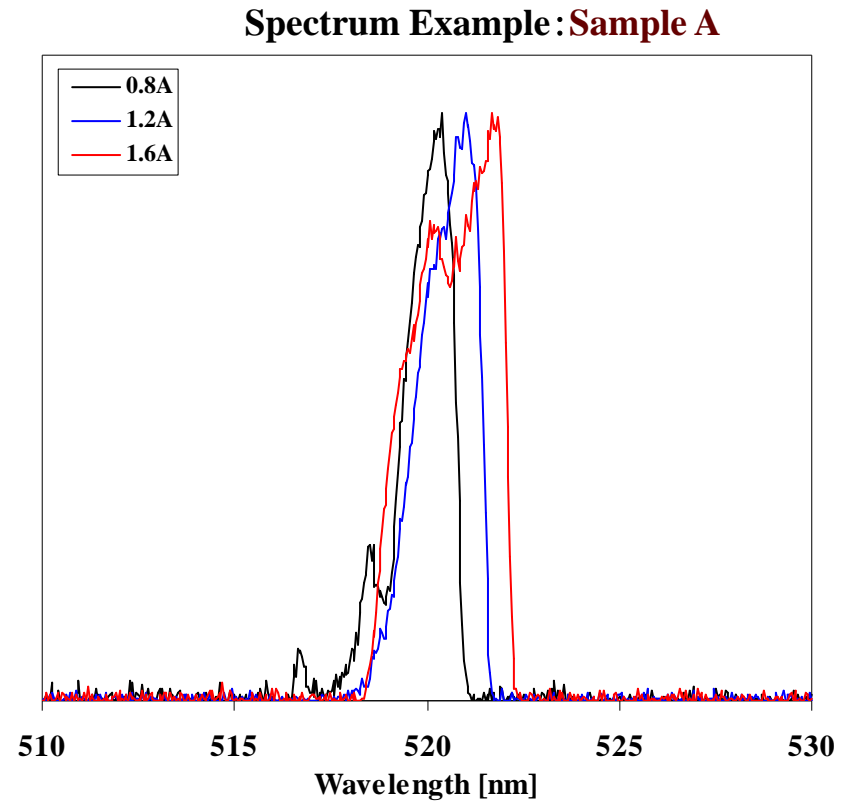
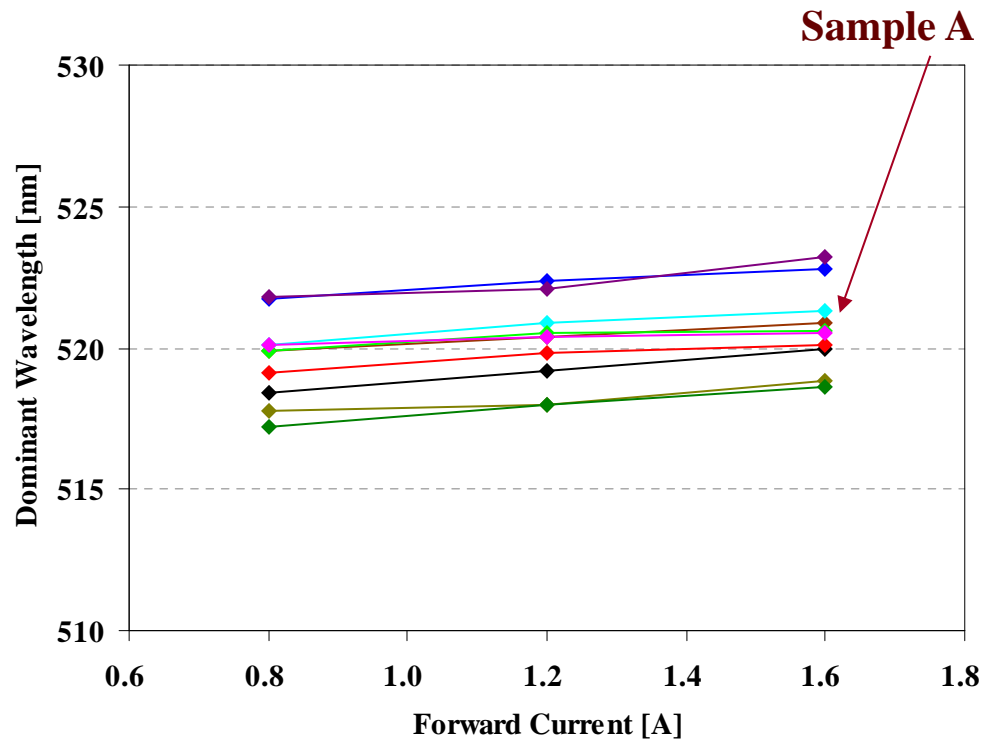

Spectrum2 (Case Temperature Dependence)

Reference Purpose Only.

Condition : Case Temperature = 0, 10, 25, 40, 60°C
Forward Current = 1.6A, CW
N = 10

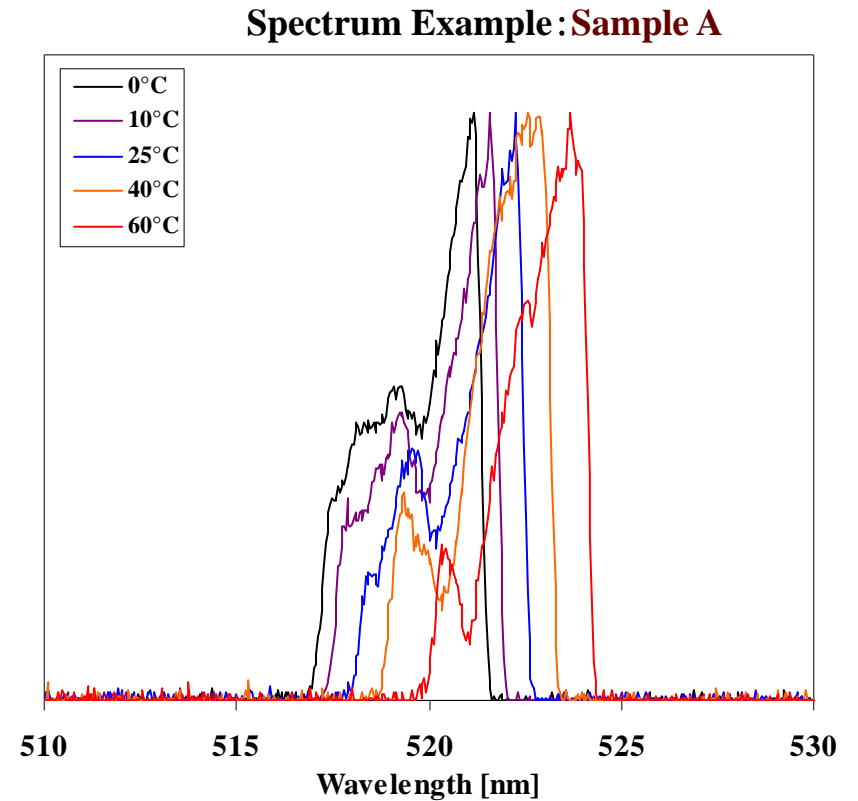
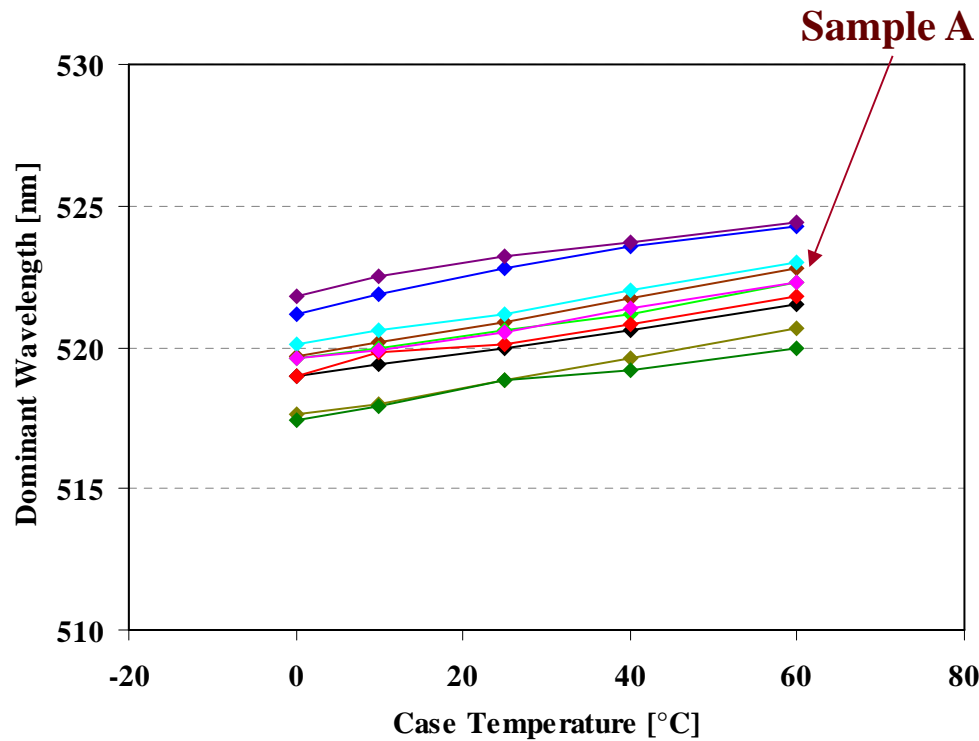

FFP1 (Typical Characteristics)

Reference Purpose Only.

Condition : Case Temperature = 25°C
 Forward Current = 1.6A, CW

Sample 1

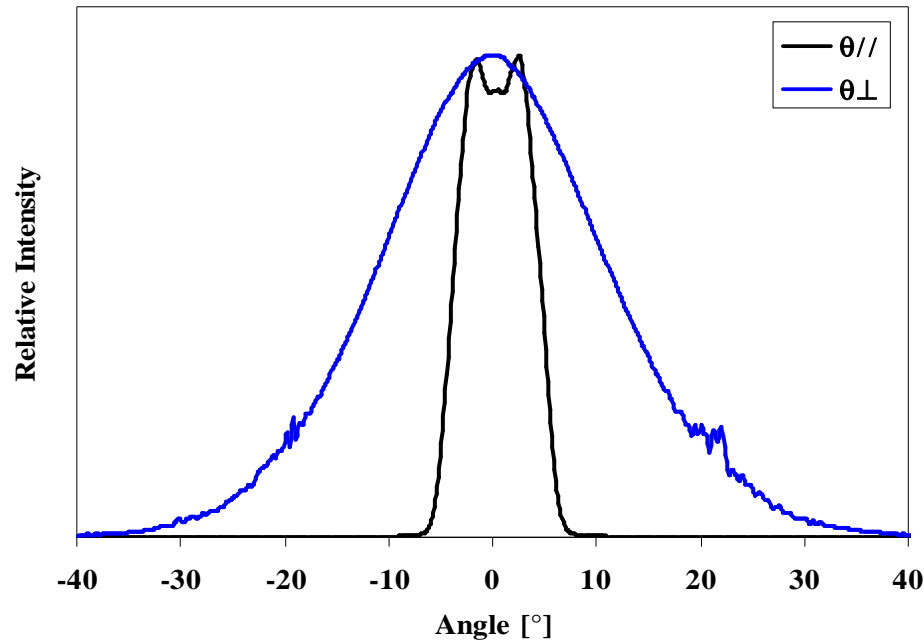
 $\theta_{//} (1/e^2) : 11.2 [^\circ]$
 $\theta_{\perp} (1/e^2) : 45.3 [^\circ]$

Sample 2

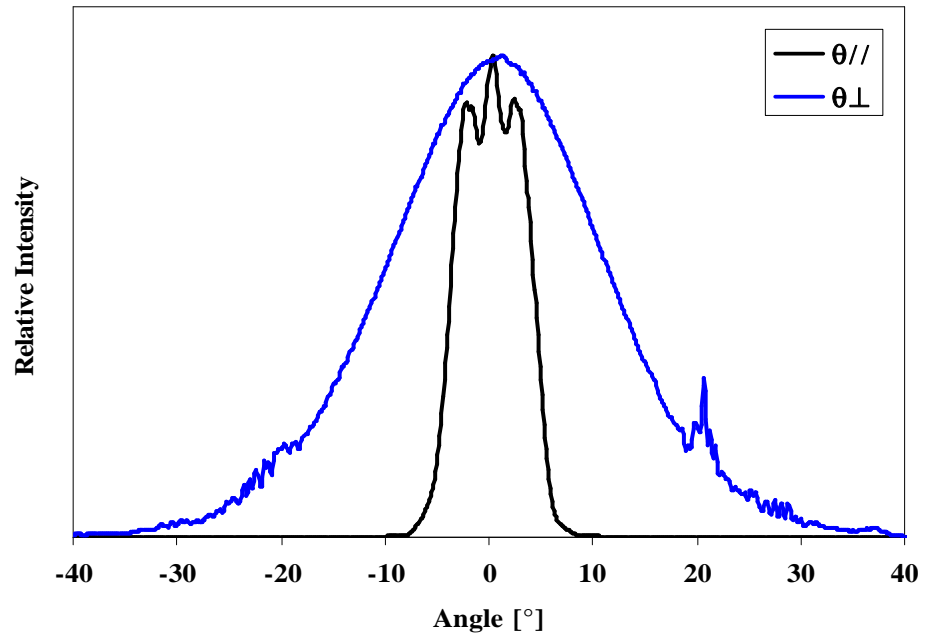
 $\theta_{//} (1/e^2) : 10.9 [^\circ]$
 $\theta_{\perp} (1/e^2) : 44.0 [^\circ]$

FFP2 (Forward Current Dependence)

Reference Purpose Only.

Condition : Case Temperature = 25°C
Forward Current = 0.8, 1.2, 1.6 A, CW
N = 10

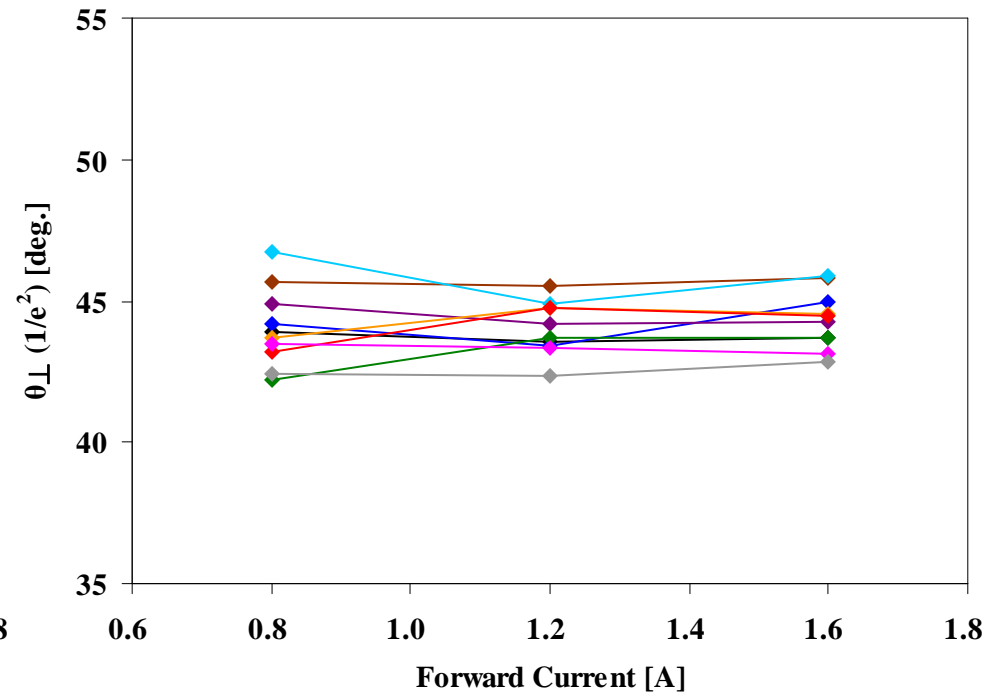
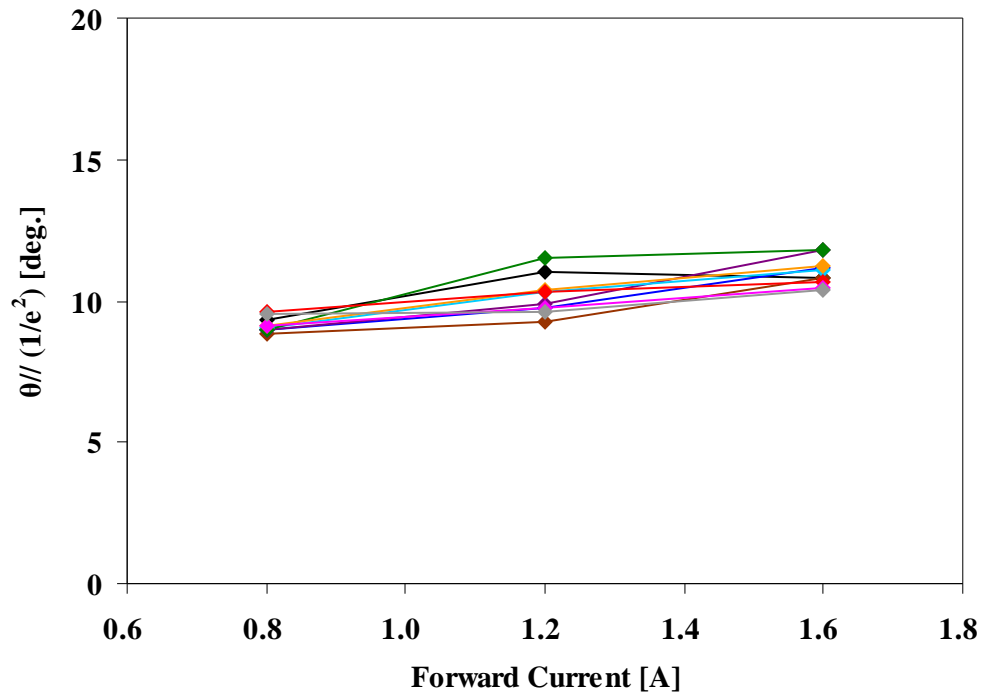

FFP3 (Case Temperature Dependence)

Reference Purpose Only.

Condition : Case Temperature = 0, 10, 25, 40, 60°C
Forward Current = 1.6A, CW
N = 10

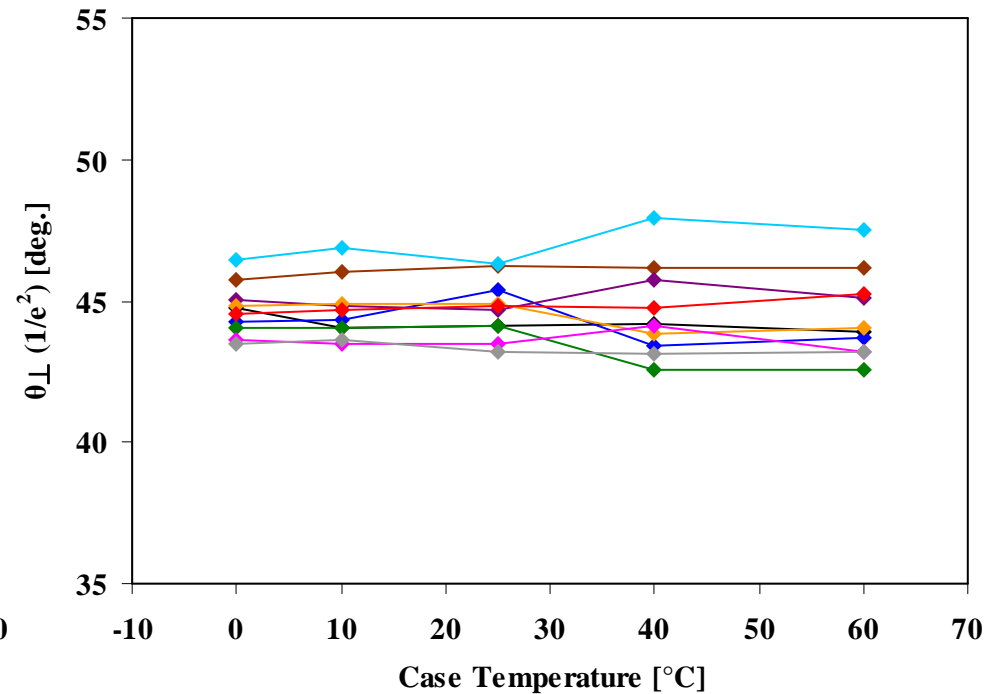
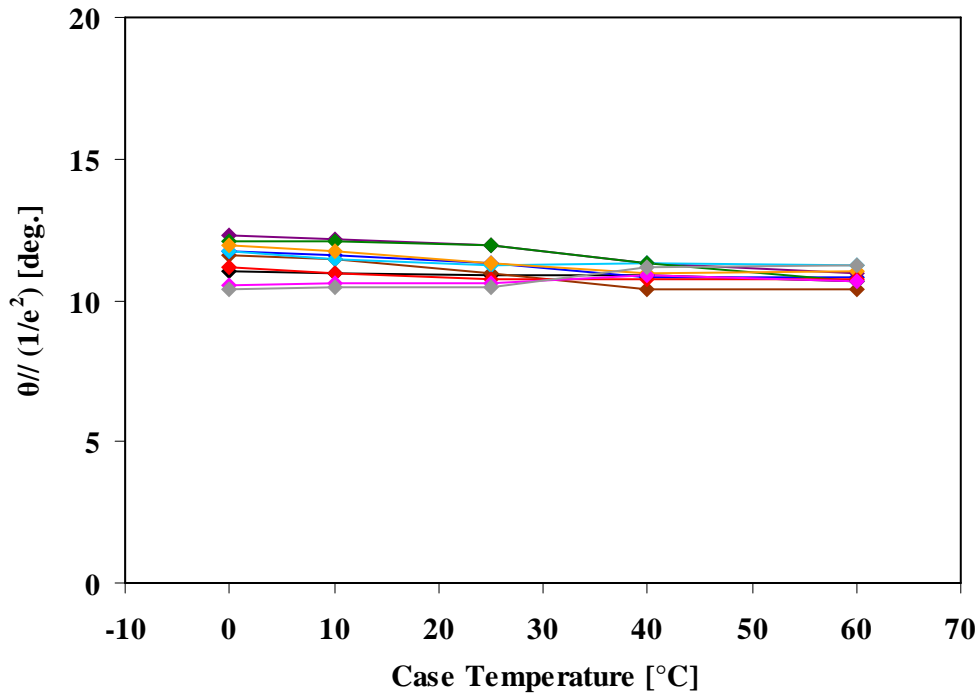

NFP (Typical Characteristics)

Reference Purpose Only.

Condition : Case Temperature = 25°C
 Forward Current = 1.6A, CW

Sample 1

// (1/e²) : 14.3 [μm]
 ⊥ (1/e²) : 0.9 [μm]

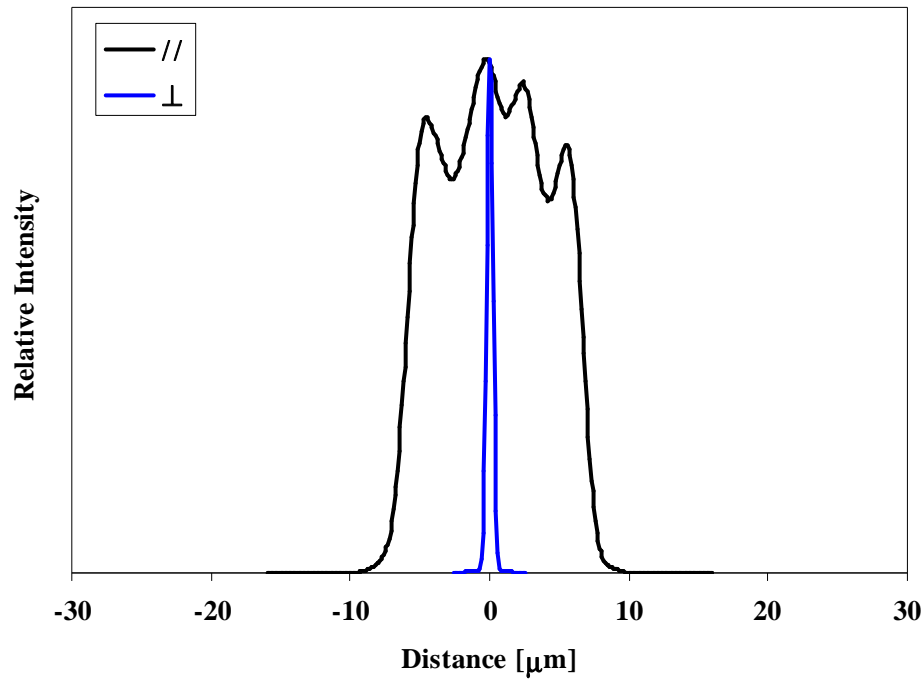

Sample 2

// (1/e²) : 14.2 [μm]
 ⊥ (1/e²) : 1.0 [μm]

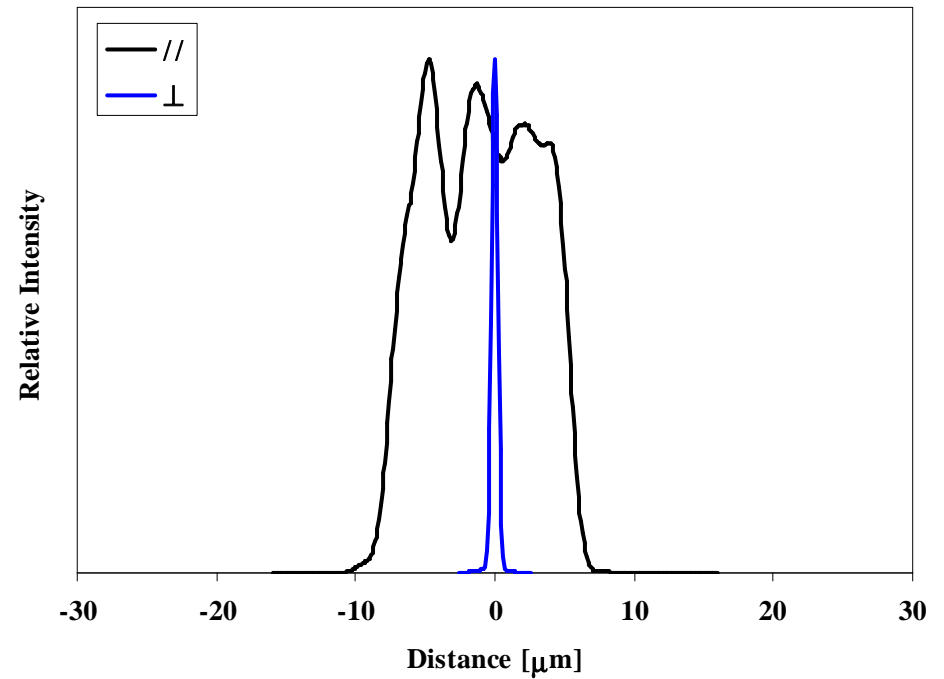

Polarization

Reference Purpose Only.

Condition : Case Temperature = 25°C
Forward Current = 1.2, 1.4, 1.6A, CW
Numerical Aperture = 0.5
N = 10

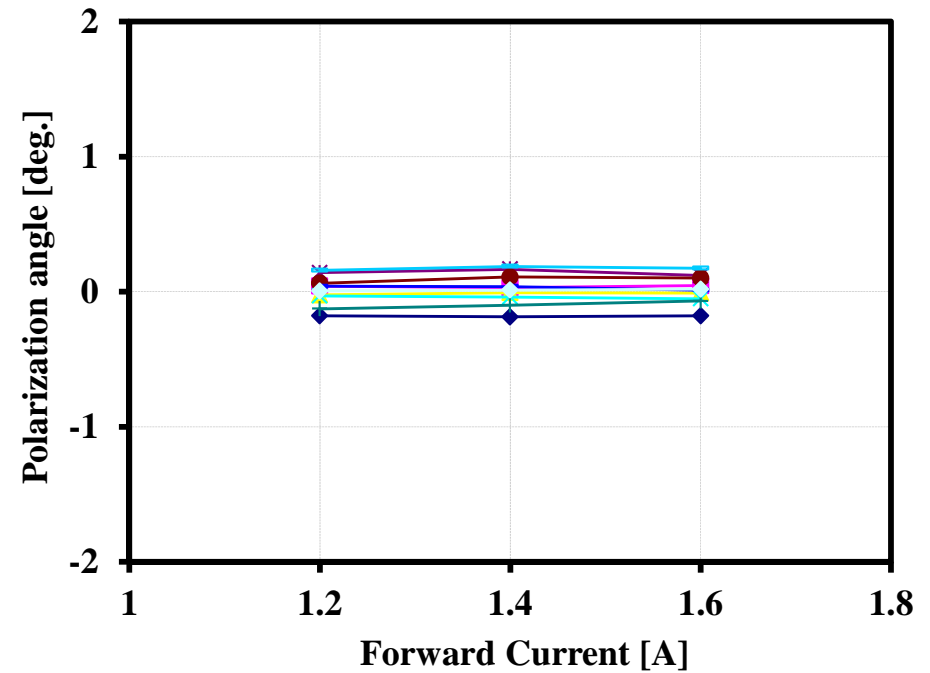
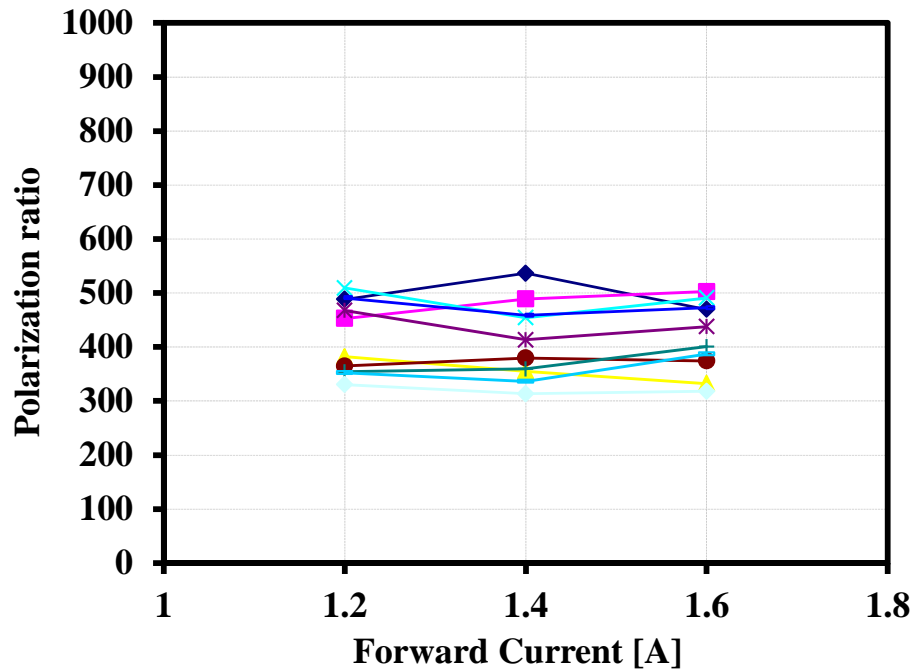
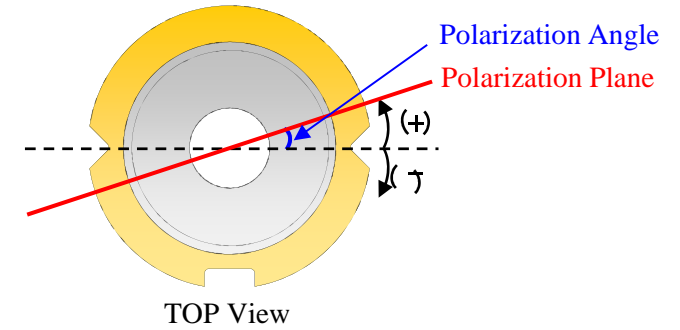

Estimated Life Time

Reference Purpose Only.

Condition : Case Temperature = 60°C
Forward Current = 1.6A(ACC), CW
Tested Duration = 1000hr, N = 24
Definition of Life-end: Initial $P_o \times 0.5$

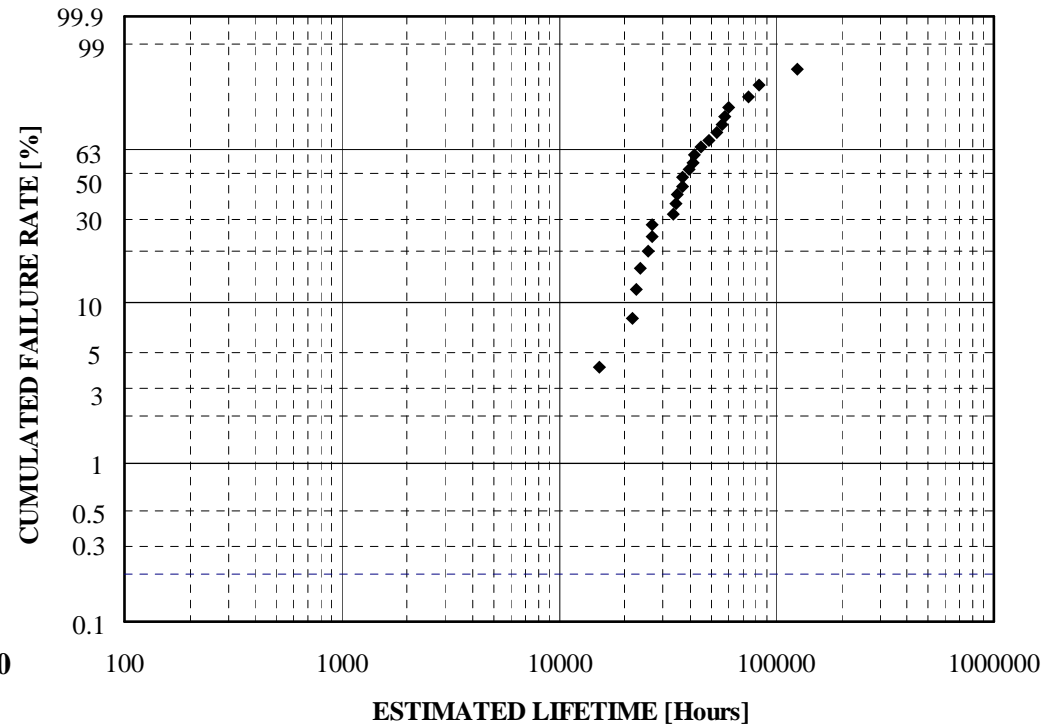
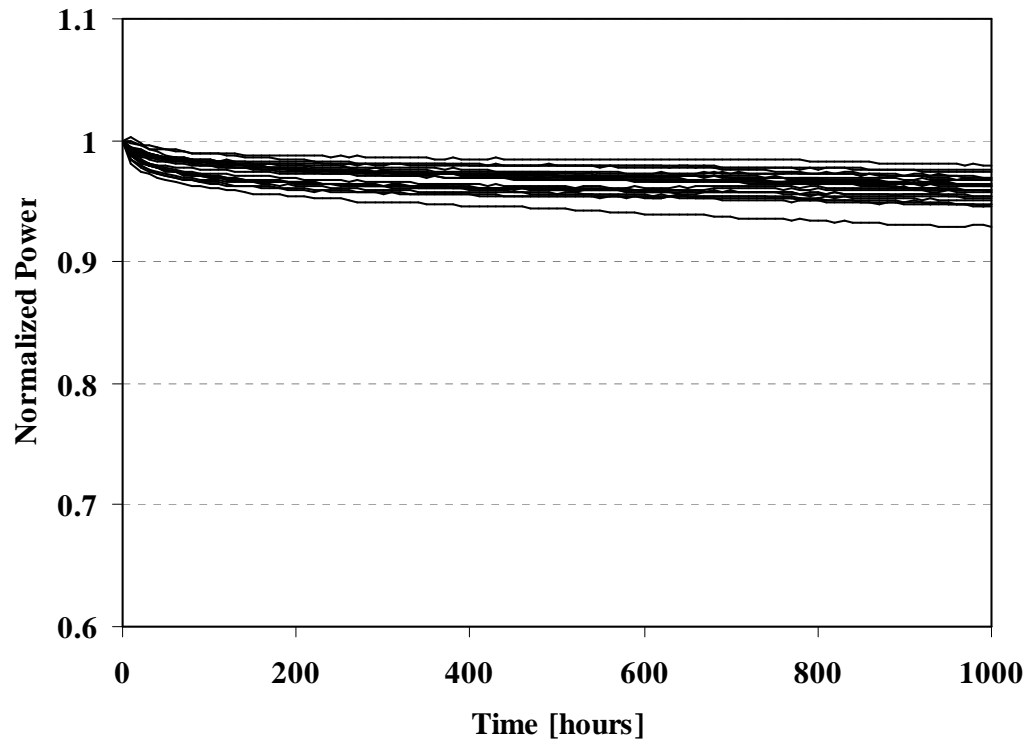

※ This weibull data is estimated by 1000 hours life test.

Nichia does not guarantee this data and will update this data as needed.